

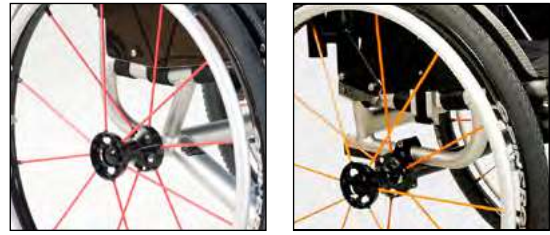

11100000500?	
14100000190?	

619000001009		
619000001109		
619000001209		
619000001309		
619000001409		
619000001509		
619000002009		
619000002109		
619000002509		
619000002809		
619000003209		
619000003309		
619000003409		
619000003509		
619000003709		
619000003809		
619000003909		
619000003009		
750 €		
000000001102		
0 €		

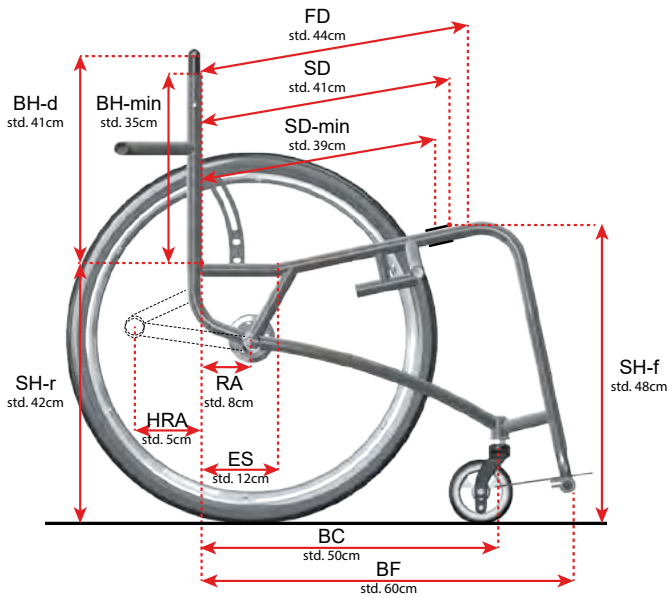

	!		SW: _____ cm
	!		FD: _____ cm SD: _____ cm SD-min: _____ cm
	!		SH-r _____ cm
	!		SH-f: _____ cm
	!		C: _____ °
	!		BH: _____ cm
			BH-d: _____ cm
			BH-max: _____ cm
			BH-min: _____ cm
	!		RA: _____ cm
69100001010? 730 €			HRA: _____ cm
610000001009 610000??0001 255 €		!	ES: _____ cm
			BF: _____ cm
			BC: _____ cm
			CW: _____ cm
			TW: _____ cm

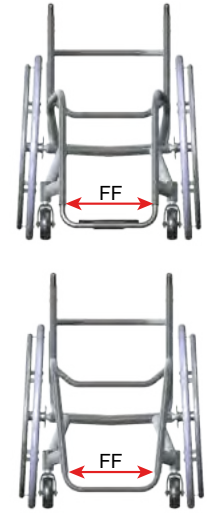
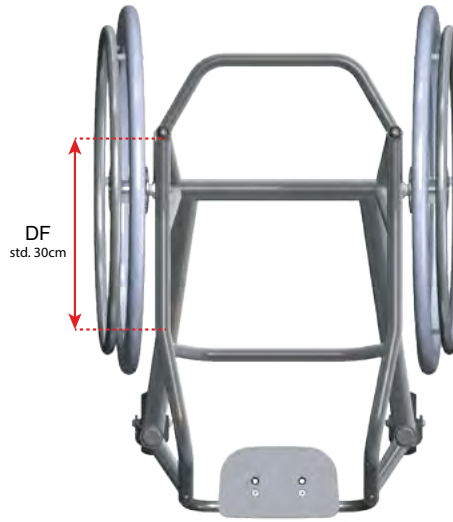
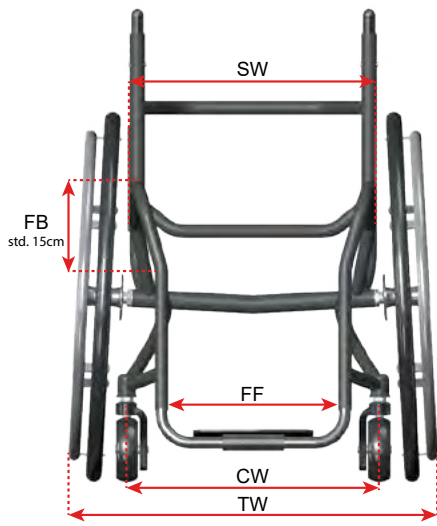

	!		FF: _____ cm
			FB: _____ cm
	!		FF: _____ cm
			DF: _____ cm
			FF: _____ cm



8861101013?? 325 €	!		
8861101013?? 325 €			
		AF: _____ cm	
		AW: _____ cm	
886110102001 325 €			

--	--

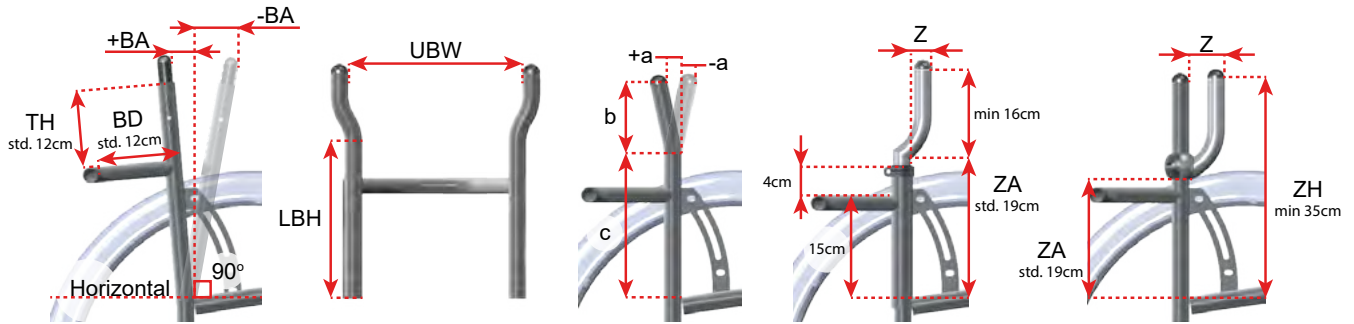

813100050???				
0 €				
813100051???				BA: _____ ±cm
366 €				
691000010130				
68 €				
813100053???				
498 €	!			SW-s: _____ cm

81220020000?				UBW: _____ cm
246 €				LBH: _____ cm
812200200020				a: _____ cm
147 €				b: _____ cm
				c: _____ cm
	!			BD: _____ cm
				TH: _____ cm

8122002001??				
560 €				!
8122002001??				
723 €				
82501000????				_____ cm
560 €	!			ZA: _____ cm
8122002001??				Z: _____ cm
930 €				ZH: _____ cm
8122002001??				
930 €				

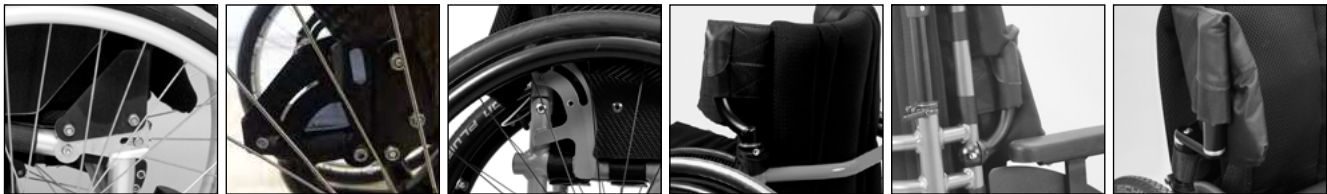

--	--

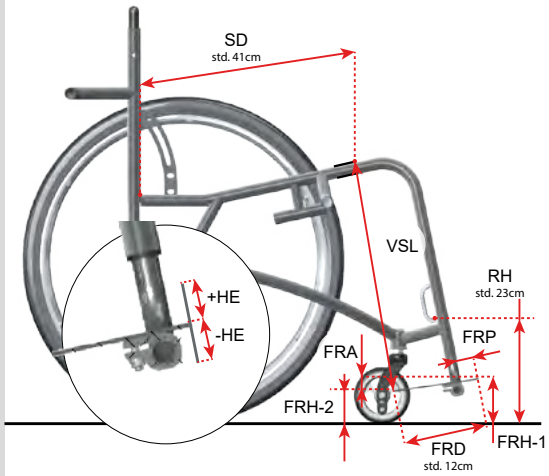

Fill in and send to Wolturnus - Ausfüllen und an Wolturnus senden - Udfyld og send til Wolturnus

Subject to Technical Modifications and Printing Errors / Technische Änderungen und Druckfehler vorbehalten
Forbehold for tekniske ændringer og trykfejl

© Wolturnus A/S W6SL / Dalton Light 2024 v4.0

				VSL/USL: _____ cm
				FRH-1: _____ cm
				FRH-2: _____ cm
				-1,5 -3 +1,5 +3
820ØFF00FR00 0 € 141 €				
82??99000000 314 €			Custom FRD _____ cm	
829999020004 382 €			HE: _____ ±cm	
8299990000?9 0 €				
8299990100?1 272 €				FRD: _____ cm
8299990100?5 225 €				FRA: _____ cm
8299990100?3 524 €				FRD std. 12 cm FRA std. 1 cm
8400100001?? 0 €				
829999020090 230 €				
835099210001 68 €		!		
829999012001 37 €				HE: _____ ±cm
				FRP: _____ cm
691000010001 68 €				RH: _____ cm











--	--

761000000010 245 €							
		+0	1+	2+	3+	4+	5+
		+0	1+	2+	3+	4+	5+

710000000001 0 €							
710099990010 440 €							
710099990012 470 €							
710099990013 470 €							
710099990011 470 €							

710099990001 0 €							
710099990003 185 €							
710099990004 185 €							
710099990002 185 €							
710099990000 0 €							

750000009000 265 €		!				
- 0 €		_____ cm / _____ cm				
750000000005 68 €	!			5cm Std.	7cm	
				Medium Std.	Hard	

885110101001 0 €			
885110101003 0 €			
885110111001 199 €			
885110122002 60 €			
88511012200? 120 €			
885110201009 157 €			
885110200909 199 €			
885110101101 199 €			
885110111101 199 €			
951519204000 90 € 180 €			
885110201209 225 €			
885110201300 250 €			
85511020130? 400 €			
951500020019 70 €			
691000020001 170 €			

				
881000100003 0 €				
881000600003 0 €				
881000?0000 340 €				
88100010000? 0 €				
88100040000? 300 €				
8810005000?? 744 €				
88100020000? 725 €				
8810003000?? 800 €				

883124101014 240 €			
681000010002 70 €			
681000010052 70 €			
7670000000?? 170 €			

		GH: _____ cm
		GL: _____ cm
		MC: _____ cm

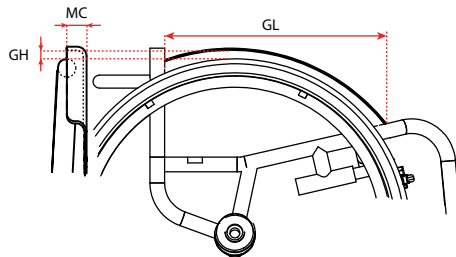

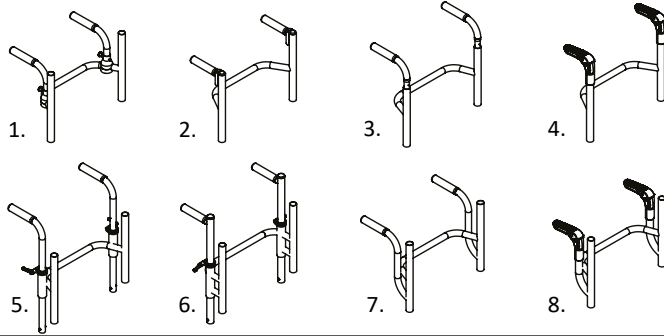

--	--









81310005??09 330 €		1.	
81310005?106 314 €		2.	
81310005?206 367 €			
81310005?108 314 €		3.	
81310005?208 367 €			
81310005?107 183 €		4.	
81310005?207 230 €			

81310005??02 524 €		5.	
81310005??03 524 €		6.	
81310005??04 367 €		7.	
81310005??05 576 €		8.	

			PH: _____ cm
--	--	--	--------------



69100002002? 275 €			
886210101001 340 €			
7600000100?? 68 € 63 €			
76100000000? 162 € 225 €			
7711000007?? 110 € 110 € 110 €			
771100000747 110 €			
953001040120 110 €			



--	--	--	--

966401253410		178 €		
966401003410		178 €		
966401253400		0 €		
966401003400		0 €		
966401003403		0 €		
966401003402		0 €		
966401003401		0 €		
966401003404		0 €		
860020000000		+52 €		
966401250120		325 €		
966401250220		325 €		
966401250320		325 €		
966401250020		325 €		
966401000120		325 €		
966401000220		325 €		
966401000320		325 €		
966401000110		325 €		
966401250?20		377 €		
966401250620		377 €		
966401250520		377 €		
966401250420		377 €		
966401000?20		377 €		
966401000620		377 €		
966401000520		377 €		
966401000420		377 €		
952100000005		0 €		
952100000004		0 €		

--	--

	22"	24"	25"	26"	
85102??01009					0 €
85102?10100?	-			-	0 €
8510??101002				-	257 €
851124201009	-		-	-	471 €

	22"	24"	25"	26"		
85352?101008					895 €	
85352?101208					895 €	
85352?101508	-				895 €	
85352?101308					895 €	
85352?102108					895 €	
85352?101009					695 €	
85352?101209					695 €	
85352?101509	-				695 €	
85352?101309					695 €	
85352?101?09					695 €	

85352?101608					950 €	
85352?101408	-			-	950 €	
85352?101808					950 €	
85352?101708					950 €	
85362?241008					950 €	
85362?241208	-				950 €	
85362?241508					950 €	
85362?241308					950 €	
85362?181008					950 €	
85362?181208	-				950 €	
85362?181508					950 €	
85362?181308					950 €	

85342410042?	-				4.230 €	
85342410043?				-	4.545 €	

--	--

	22"	24"	25"	26"	
96622?010001				-	0 €
96622?01000?					68 €
96622?010009					146 €
96622?010021			-	-	146 €
966224010013	-		-	-	68 €
96622?011008	-			-	68 €
966224010007	-		-	-	68 €

85512?10200?					0 €
85512?102008	-			-	194 €
85502?103009	-				178 €
85552?000009					503 € 629 €
8554202?0601	-				315 €
8554262?0601	-				575 €
8554272?0601	-				575 €
8554282?0601					700 €
9669282?0602					700 €
8554302?0601					700 €
8554502?060?	-			-	700 €
8554502?060?	-			-	700 €

			!		
--	--	--	---	--	--

85712?102009					178 €
--------------	--	--	--	--	-------

--	--	--	--	--	--

000000001104 100 €					
-----------------------	--	--	--	--	--

EN ISO 14971

--	--	--	--	--	--

P.4	
P.5	
P.6	
P.7	
P.9	
P.10	
P.11	
P.12	
P.13	
P.14	

